

### Description

The LM8S6NP03 uses advanced trench technology to provide excellent  $R_{DS(ON)}$ , low gate charge and operation with gate voltages as low as 4.5V. This device is suitable for use as a Battery protection or in other Switching application.

### General Features

$V_{DS} = 30V$   $I_D = 10 A$

$R_{DS(ON)} < 25m\Omega$  @  $V_{GS}=10V$

$V_{DS} = -30V$   $I_D = -7.6 A$

$R_{DS(ON)} < -48m\Omega$  @  $V_{GS}=10V$

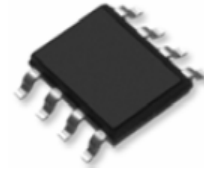
### Application

Battery protection

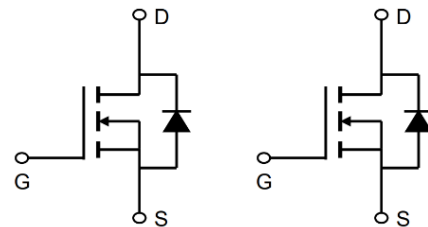
Load switch

Uninterruptible power supply

### Dimensions SOP-8



### Pin Configuration



### Package Marking and Ordering Information

Product ID	Pack	Marking	Qty(PCS)
LM8S6NP03	SOP-8	AP6G03S XXX YYYY	3000

### Absolute Maximum Ratings ( $T_C=25^\circ C$ unless otherwise noted)

Symbol	Parameter	Rating		Units
		N-Ch	P-Ch	
$V_{DS}$	Drain-Source Voltage	30	-30	V
$V_{GS}$	Gate-Source Voltage	$\pm 20$	$\pm 20$	V
$I_D@T_C=25^\circ C$	Continuous Drain Current, $V_{GS}$ @ 10V <sup>1</sup>	10	-7.6	A
$I_D@T_C=100^\circ C$	Continuous Drain Current, $V_{GS}$ @ 10V <sup>1</sup>	6	-5.9	A
IDM	Pulsed Drain Current <sup>2</sup>	20	-15	A
EAS	Single Pulse Avalanche Energy <sup>3</sup>	22	45	mJ
IAS	Avalanche Current	21	-30	A
$P_D@T_C=25^\circ C$	Total Power Dissipation <sup>4</sup>	2.0	2.0	W
TSTG	Storage Temperature Range	-55 to 150	-55 to 150	$^\circ C$
$T_J$	Operating Junction Temperature Range	-55 to 150	-55 to 150	$^\circ C$
$R_{\theta JA}$	Thermal Resistance Junction-Ambient <sup>1</sup>	---	62	$^\circ C/W$
$R_{\theta JC}$	Thermal Resistance Junction-Case <sup>1</sup>	---	5	$^\circ C/W$

## N-Channel Electrical Characteristics ( $T_J=25^\circ\text{C}$ , unless otherwise noted)

Symbol	Parameter	Conditions	Min.	Typ.	Max.	Unit
$BV_{DSS}$	Drain-Source Breakdown Voltage	$V_{GS}=0V, I_D=250\mu A$	30	---	---	V
$\Delta BV_{DSS}/\Delta T_J$	BVDSS Temperature Coefficient	Reference to $25^\circ\text{C}$ , $I_D=1\text{mA}$	---	0.023	---	$V/^\circ\text{C}$
$R_{DS(on)}$	Static Drain-Source On-Resistance <sup>2</sup>	$V_{GS}=10V, I_D=10A$	---	20	25	m $\Omega$
		$V_{GS}=4.5V, I_D=5A$	---	30	38	
$V_{GS(th)}$	Gate Threshold Voltage		1.0	1.7	2.5	V
$\Delta V_{GS(th)}$	$V_{GS(th)}$ Temperature Coefficient	$V_{GS}=V_{DS}, I_D=250\mu A$	---	-5.2	---	mV/ $^\circ\text{C}$
$I_{DSS}$	Drain-Source Leakage Current	$V_{DS}=24V, V_{GS}=0V, T_J=25^\circ\text{C}$	---	---	1	uA
		$V_{DS}=24V, V_{GS}=0V, T_J=55^\circ\text{C}$	---	---	5	
$I_{GSS}$	Gate-Source Leakage Current	$V_{GS}=\pm 20V, V_{DS}=0V$	---	---	$\pm 100$	nA
$g_{fs}$	Forward Transconductance	$V_{DS}=5V, I_D=10A$	---	16	---	S
$R_g$	Gate Resistance	$V_{DS}=0V, V_{GS}=0V, f=1\text{MHz}$	---	2.5	5	$\Omega$
$Q_g$	Total Gate Charge (4.5V)	$V_{DS}=20V, V_{GS}=4.5V, I_D=10A$	---	7.2	---	nC
$Q_{gs}$	Gate-Source Charge		---	1.4	---	
$Q_{gd}$	Gate-Drain Charge		---	2.2	---	
$T_{d(on)}$	Turn-On Delay Time	$V_{DD}=15V, V_{GS}=10V, R_G=3.3\Omega, I_D=5A$	---	4.1	---	ns
$T_r$	Rise Time		---	9.8	---	
$T_{d(off)}$	Turn-Off Delay Time		---	15.5	---	
$T_f$	Fall Time		---	6.0	---	
$C_{iss}$	Input Capacitance	$V_{DS}=15V, V_{GS}=0V, f=1\text{MHz}$	---	572	---	pF
$C_{oss}$	Output Capacitance		---	81	---	
$C_{rss}$	Reverse Transfer Capacitance		---	65	---	
$I_S$	Continuous Source Current <sup>1,5</sup>	$V_G=V_D=0V, \text{Force Current}$	---	---	10	A
$I_{SM}$	Pulsed Source Current <sup>2,5</sup>		---	---	20	A
$V_{SD}$	Diode Forward Voltage <sup>2</sup>		$V_{GS}=0V, I_S=1A, T_J=25^\circ\text{C}$	---	---	1.2

Note :

- 1.The data tested by surface mounted on a 1 inch<sup>2</sup> FR-4 board with 2OZ copper.
- 2.The data tested by pulsed , pulse width  $\leq 300\mu s$  , duty cycle  $\leq 2\%$
- 3.The EAS data shows Max. rating . The test condition is  $V_{DD}=25V, V_{GS}=10V, L=0.1\text{mH}, I_{AS}=21A$
- 4 .The power dissipation is limited by  $150^\circ\text{C}$  junction temperature
- 5.The data is theoretically the same as  $I_D$  and  $I_{DM}$  , in real applications , should be limited by total power dissipation.

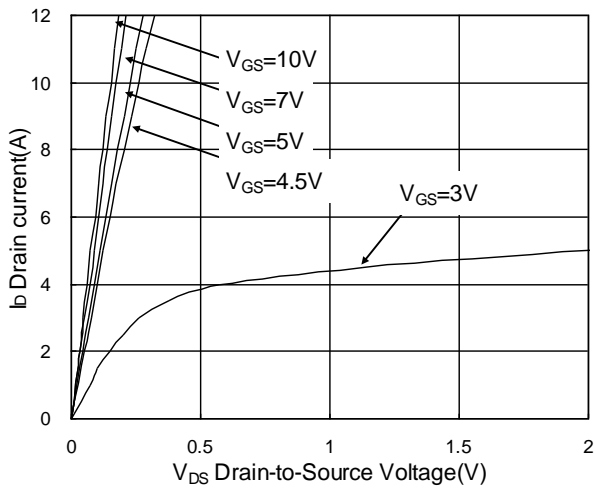
**P-Channel Electrical Characteristics (T<sub>J</sub>=25 °C, unless otherwise noted)**

Symbol	Parameter	Conditions	Min.	Typ.	Max.	Unit
BV <sub>DSS</sub>	Drain-Source Breakdown Voltage	V <sub>GS</sub> =0V , I <sub>D</sub> =-250uA	-30	---	---	V
ΔBV <sub>DSS</sub> /ΔT <sub>J</sub>	BV <sub>DSS</sub> Temperature Coefficient	Reference to 25°C , I <sub>D</sub> =-1mA	---	-0.021	---	V/°C
R <sub>DS(ON)</sub>	Static Drain-Source On-Resistance <sup>2</sup>	V <sub>GS</sub> =-10V , I <sub>D</sub> =-7A	---	39	48	mΩ
		V <sub>GS</sub> =-4.5V , I <sub>D</sub> =-5A	---	53	58	
V <sub>GS(th)</sub>	Gate Threshold Voltage		-1.0	-1.6	-2.5	V
ΔV <sub>GS(th)</sub>	V <sub>GS(th)</sub> Temperature Coefficient	V <sub>GS</sub> =V <sub>DS</sub> , I <sub>D</sub> =-250uA	---	-4.2	---	mV/°C
I <sub>DSS</sub>	Drain-Source Leakage Current	V <sub>DS</sub> =-24V , V <sub>GS</sub> =0V , T <sub>J</sub> =25°C	---	---	1	uA
		V <sub>DS</sub> =-24V , V <sub>GS</sub> =0V , T <sub>J</sub> =55°C	---	---	5	
I <sub>GSS</sub>	Gate-Source Leakage Current	V <sub>GS</sub> = ± 20V , V <sub>DS</sub> =0V	---	---	± 100	nA
g <sub>fs</sub>	Forward Transconductance	V <sub>DS</sub> =-5V , I <sub>D</sub> =-7A	---	15	---	S
R <sub>g</sub>	Gate Resistance	V <sub>DS</sub> =0V , V <sub>GS</sub> =0V , f=1MHz		15	30	
Q <sub>g</sub>	Total Gate Charge (-4.5V)	V <sub>DS</sub> =-20V , V <sub>GS</sub> =-4.5V , I <sub>D</sub> =-7A	---	9.8	---	nC
Q <sub>gs</sub>	Gate-Source Charge		---	2.2	---	
Q <sub>gd</sub>	Gate-Drain Charge		---	3.4	---	
T <sub>d(on)</sub>	Turn-On Delay Time	V <sub>DD</sub> =-15V , V <sub>GS</sub> =-10V , R <sub>G</sub> =3.3 , I <sub>D</sub> =-5A	---	16.4	---	ns
T <sub>r</sub>	Rise Time		---	20.2	---	
T <sub>d(off)</sub>	Turn-Off Delay Time		---	55	---	
T <sub>f</sub>	Fall Time		---	10	---	
C <sub>iss</sub>	Input Capacitance	V <sub>DS</sub> =-15V , V <sub>GS</sub> =0V , f=1MHz	---	930	---	pF
C <sub>oss</sub>	Output Capacitance		---	148	---	
C <sub>rss</sub>	Reverse Transfer Capacitance		---	115	---	
I <sub>s</sub>	Continuous Source Current <sup>1,5</sup>	V <sub>G</sub> =V <sub>D</sub> =0V , Force Current	---	---	-7.6	A
I <sub>SM</sub>	Pulsed Source Current <sup>2,5</sup>		---	---	-15	A
V <sub>SD</sub>	Diode Forward Voltage <sup>2</sup>	V <sub>GS</sub> =0V , I <sub>S</sub> =-1A , T <sub>J</sub> =25°C	---	---	-1.2	V

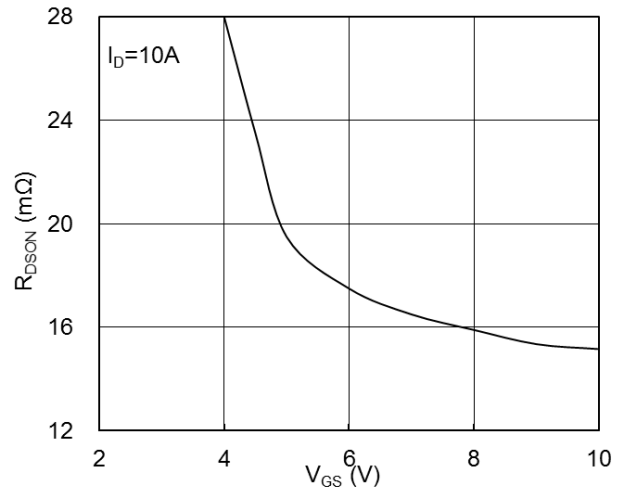
Note :

- 1.The data tested by surface mounted on a 1 inch<sup>2</sup> FR-4 board with 20Zcopper.
- 2.The data tested by pulsed , pulse width ≤ 300us , duty cycle ≤ 2%
- 3.The EAS data sh.The power dissipation is limited by ows Max. rating
4. The test condition is V150°C junction temperature<sub>DD</sub>=-25 V,V<sub>GS</sub>=-10V,L=0.1mH,I<sub>AS</sub>=-30A
- 5 .The data is theoretically the same as I<sub>D</sub> and I<sub>DM</sub> , in real applications , should be limited by total power dissipation.

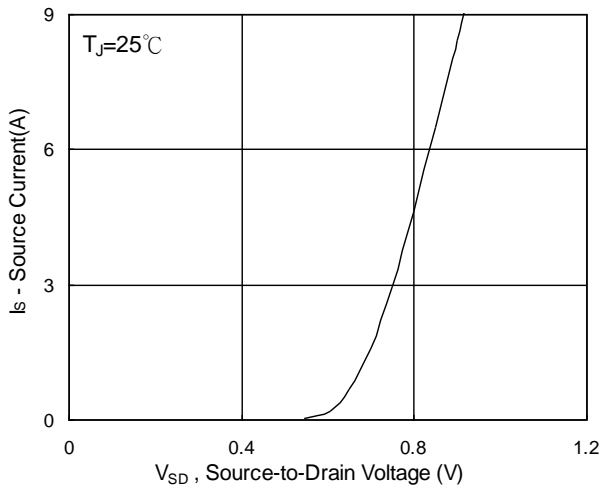
**N-Channel Typical Characteristics**



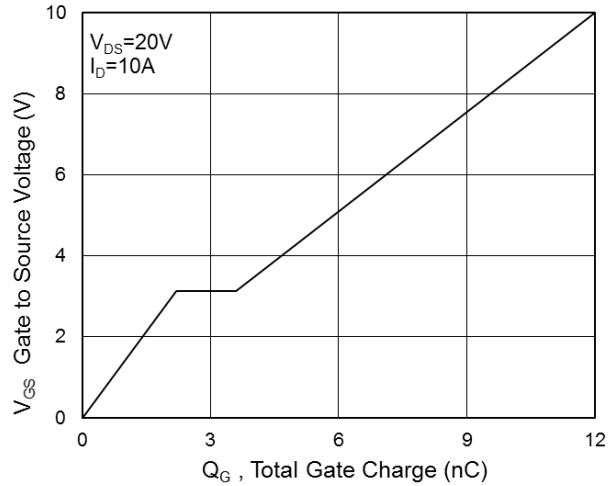
**Fig.1 Typical Output Characteristics**



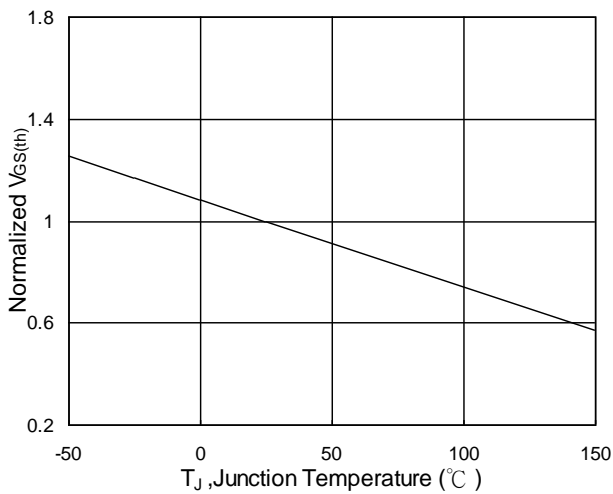
**Fig.2 On-Resistance vs Gate-Source Voltage**



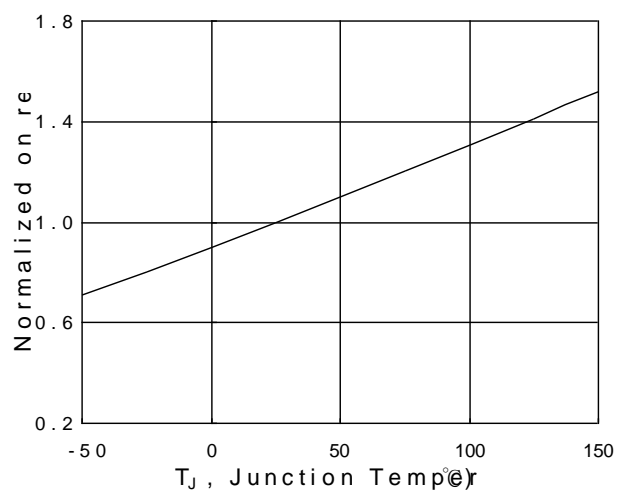
**Fig.3 Forward Characteristics of Reverse**



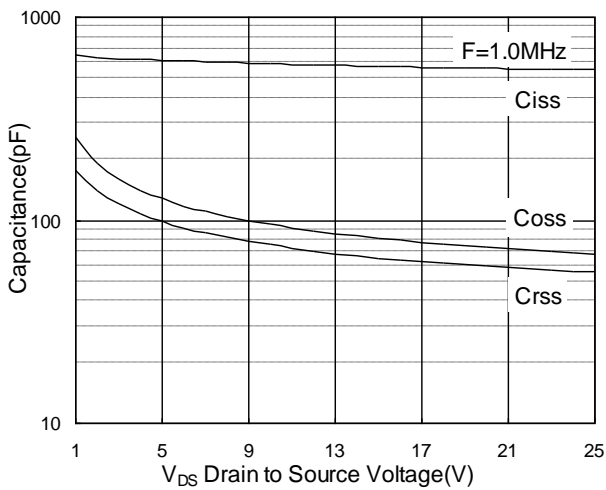
**Fig.4 Gate-Charge characteristics**



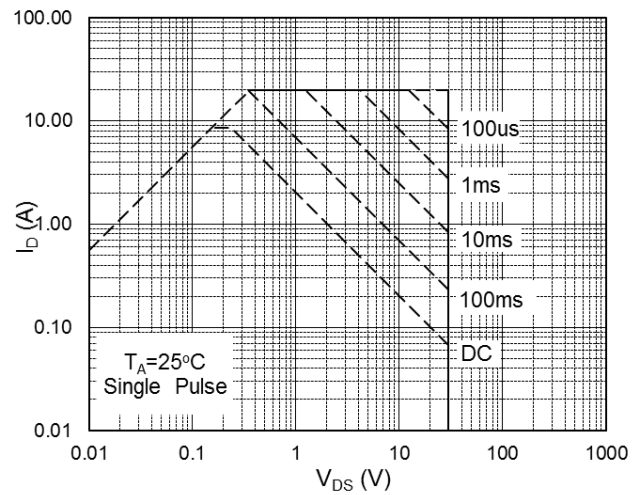
**Fig.5 Normalized  $V_{GS(th)}$  vs  $T_J$**



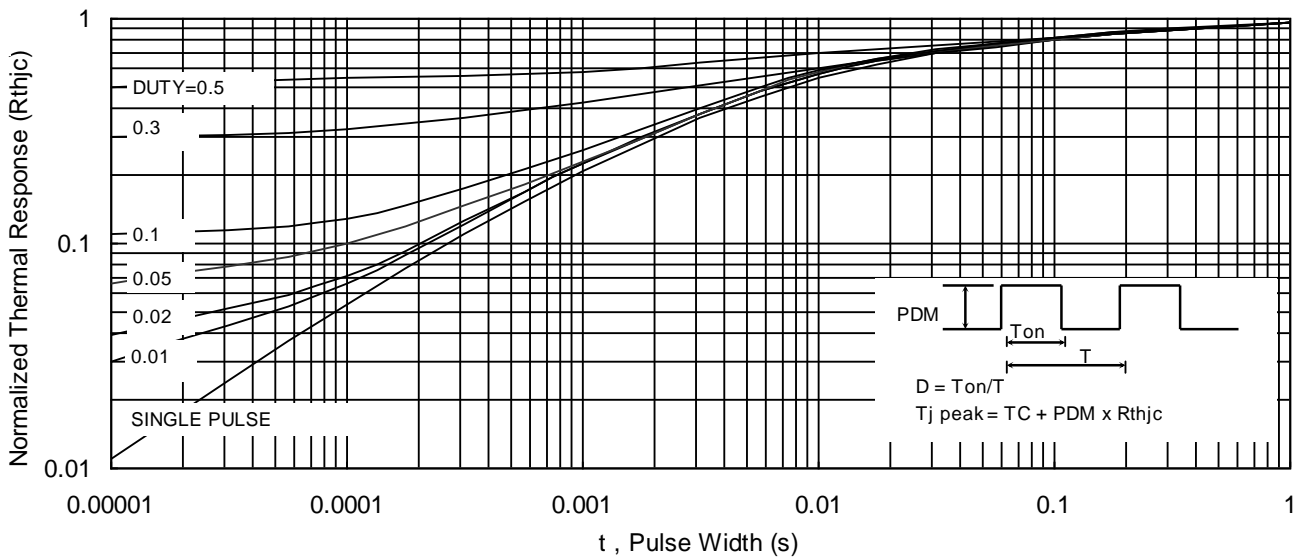
**Fig.6 Normalized  $R_{DS(on)}$  vs  $T_J$**



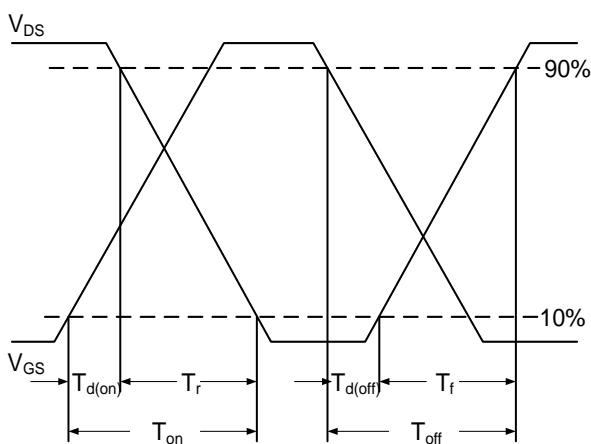
**Fig.7 Capacitance**



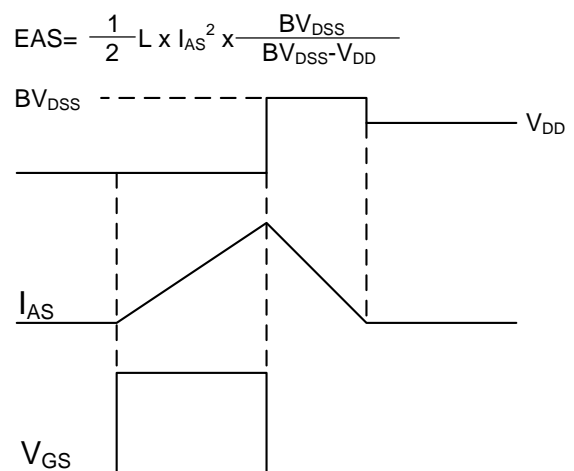
**Fig.8 Safe Operating Area**



**Fig.9 Normalized Maximum Transient Thermal Impedance**

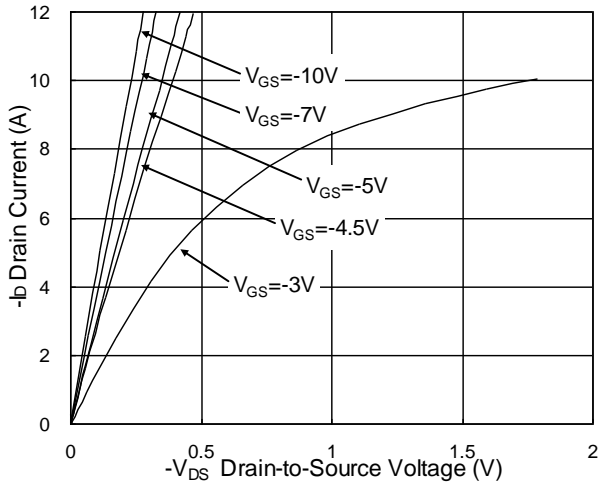


**Fig.10 Switching Time Waveform**

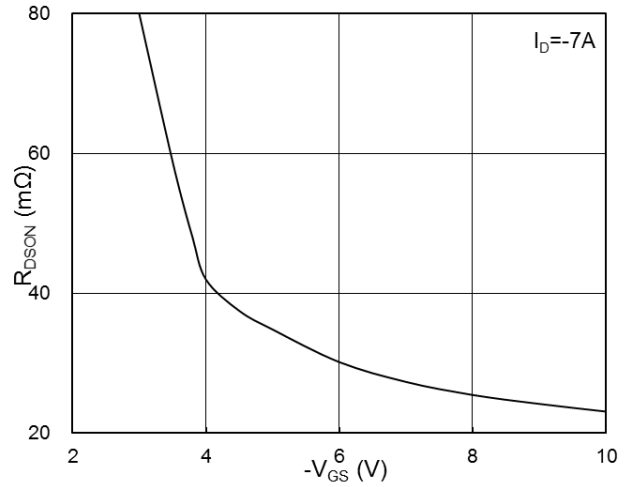


**Fig.11 Unclamped Inductive Waveform**

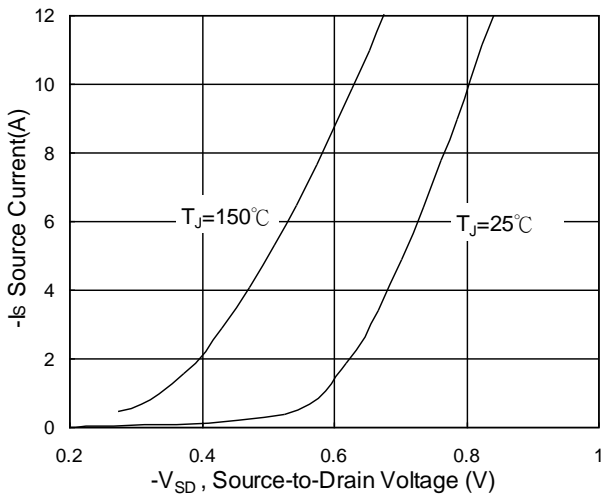
**P-Channel Typical Characteristics**



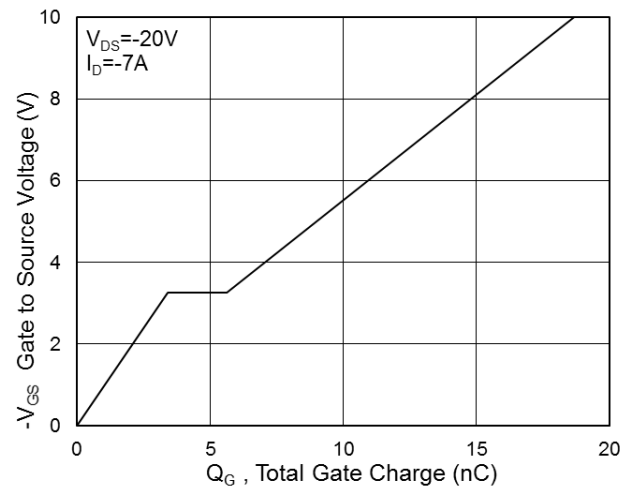
**Fig.1 Typical Output Characteristics**



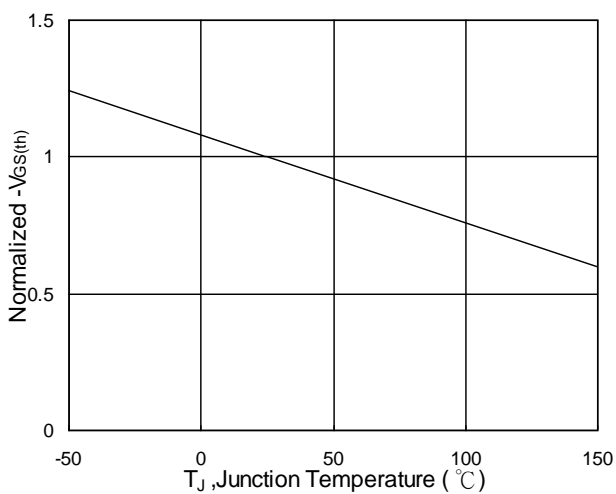
**Fig.2 On-Resistance vs Gate-Source Voltage**



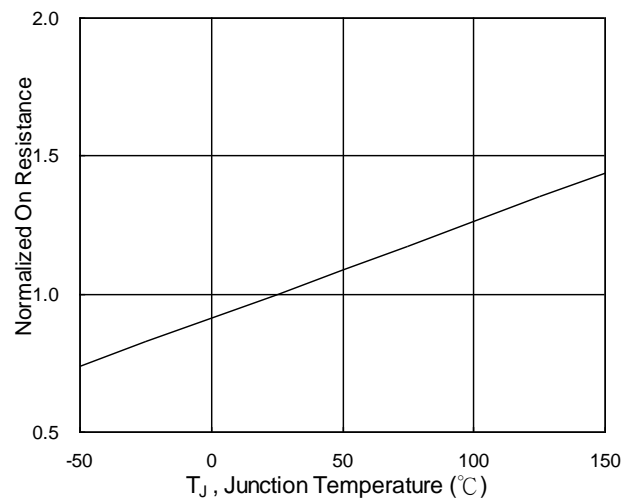
**Fig.3 Forward Characteristics of Reverse**



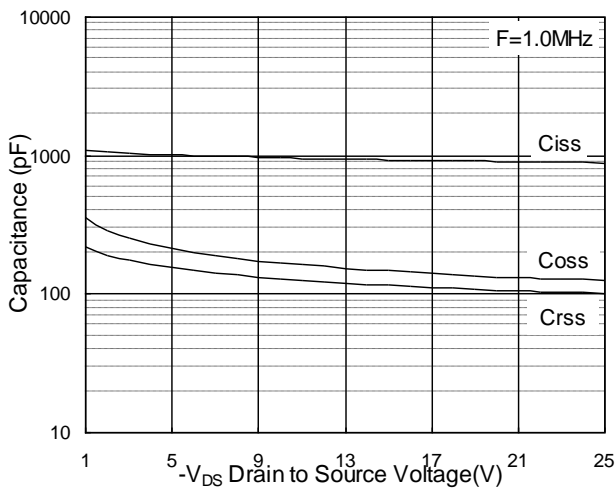
**Fig.4 Gate-Charge Characteristics**



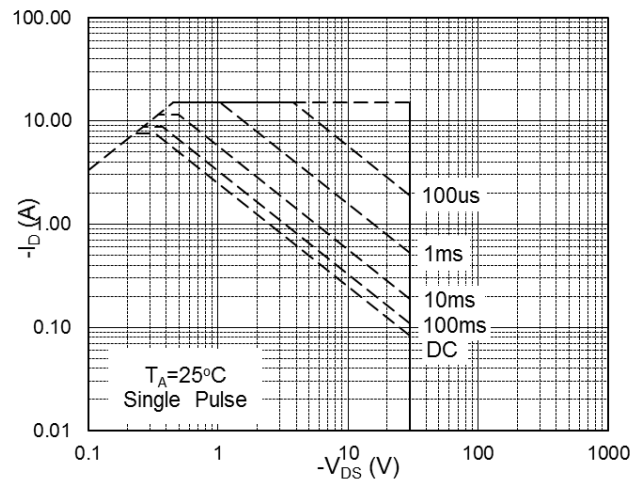
**Fig.5 Normalized  $V_{GS(th)}$  vs  $T_J$**



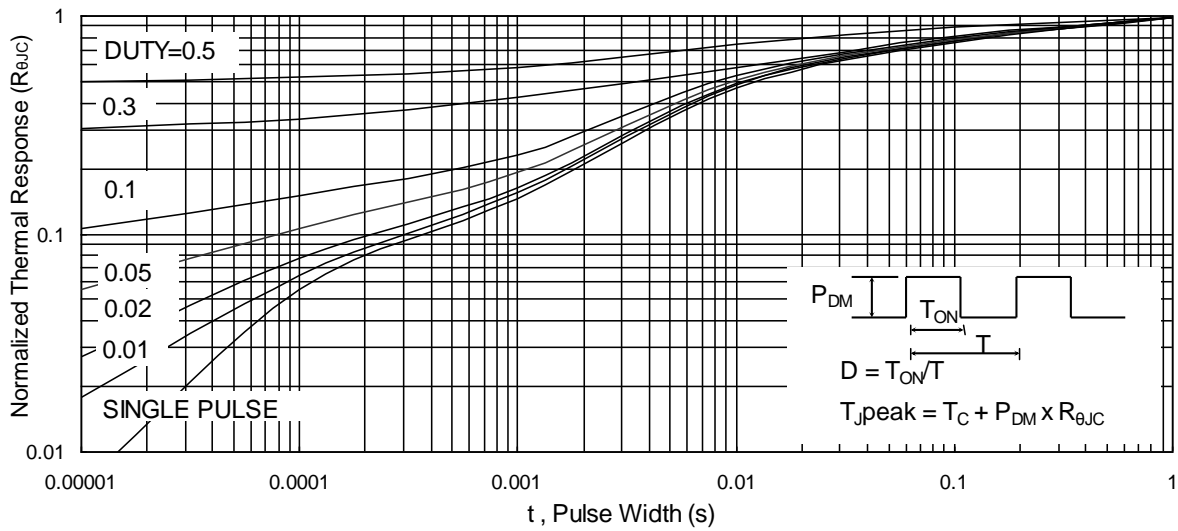
**Fig.6 Normalized  $R_{DS(on)}$  vs  $T_J$**



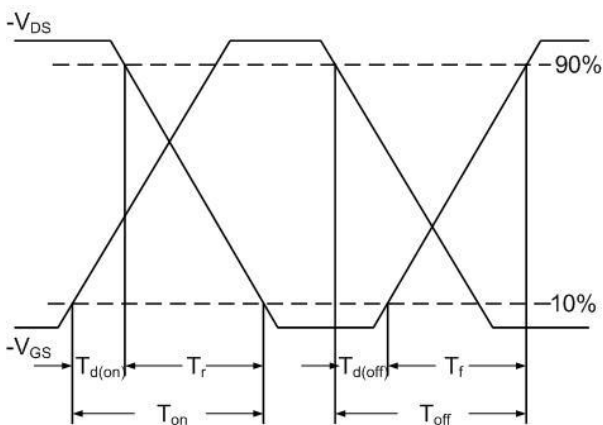
**Fig.7 Capacitance**



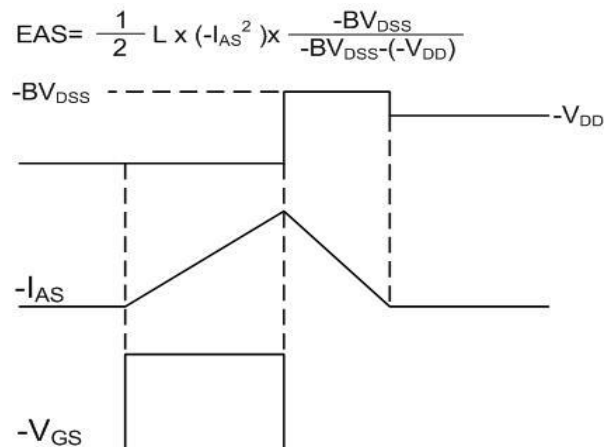
**Fig.8 Safe Operating Area**



**Fig.9 Normalized Maximum Transient Thermal Impedance**

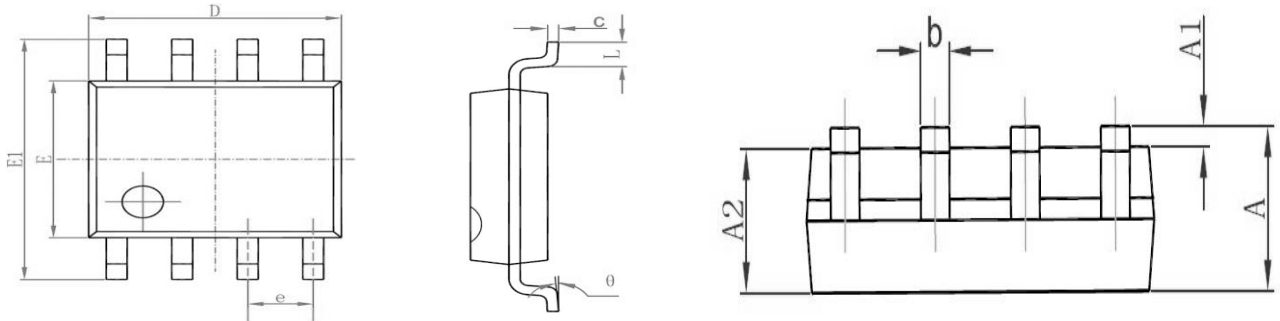


**Fig.10 Switching Time Waveform**

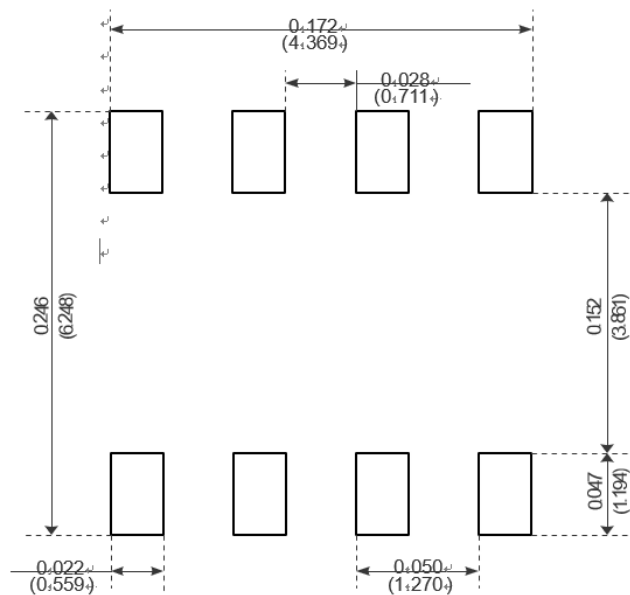


**Fig.11 Unclamped Inductive Waveform**

Package Mechanical Data-SOP-8



Symbol	Dimensions In Millimeters		Dimensions In Inches	
	Min	Max	Min	Max
A	1.350	1.750	0.053	0.069
A1	0.100	0.250	0.004	0.010
A2	1.350	1.550	0.053	0.061
b	0.330	0.510	0.013	0.020
c	0.170	0.250	0.006	0.010
D	4.700	5.100	0.185	0.200
E	3.800	4.000	0.150	0.157
E1	5.800	6.200	0.228	0.244
e	1.270 (BSC)		0.050 (BSC)	
L	0.400	1.270	0.016	0.050
θ	0°	8°	0°	8°



Recommended Minimum Pads

Shanghai Leiditech Electronic Co.,Ltd  
 Email: sale1@leiditech.com  
 Tel : +86- 021 50828806  
 Fax : +86- 021 50477059